

To be completed by GReddy

Serial Number _____ Date Received _____ Date Sent _____



TD04-19T Golf IV Turbo Kit
ECU Chip Upgrade Form

Thank you for choosing GReddy Performance Products. This form is to be completed and included with your factory ECU, when sent back to our facility to be upgraded. Please thoroughly fill out the section below. If you have any question regarding this information, please contact one of our GReddy facilities, or email us at the address info@greddy.com.

Customer information

Name _____ Date _____
Address _____ Phone _____
_____ Email _____

Vehicle Information

Make _____ Model _____
Year _____ VIN # _____

Purchase Information

Date _____ Dealer _____

Thank you for your time in completing this form.

Sincerely,

GReddy Performance Products, Inc.

GReddy Performance Products
9 Vanderbilt
Irvine, CA 91618
(949)-588-8300

GReddy Performance Products, East
4430 Bordentown Ave.
Old Bridge, NJ 08857
(732)432-4900

GReddy Turbo Kit

02-05 VW GOLF GTI IV TD04-19T 8.5cm²

Installation Manual

Please read the entire manual before installing this kit.

Application:

Make	Model	Year
VW	GOLF GTI	02-05

- This *GReddy Turbo Kit* is designed only for the vehicles specified above.
- GReddy front mount intercooler kit is recommended with this kit
- Premium grade gasoline (92 octane or higher) is required with this Kit.
- Use of **GReddy Racing Spark Plugs ISO #7** or NGK plugs (colder than factory) is recommended with this kit.

Important

1. This installation should only be performed by a trained specialist who is very familiar with the automobile's mechanical, electrical and fuel management system.
2. If installed by an untrained person, it may cause damage to the kit as well as the vehicle.
3. GReddy Performance Products Inc. is not responsible for any damage to the vehicle's electrical system caused by improper installation.

1. Parts list

1. Turbocharger	TD04-19T 8.5cm ² P1020mmHg	1
2. Turbo Adapter	(steel)	1
3. Down pipe	(50 ϕ steel)	1
4. Suction Pipe	S-1 (60 ϕ Aluminum)	1
5. Airinx AY-M	(Blue Filter)	1
6. Airinx Adapter Hose	(M80)	1
7. Airinx Adapter Pipe	(70 ϕ)	1
8. Airflow Meter		1
9. Compression Pipe	C-1 (50 ϕ Aluminum)	1
10. Oil Pressure Line	1200mm	1

11.	Oil Pressure Banjo Fitting Small (Male&Female)							1
12.	“	Big (Female)						1
13.	Plug Bolt	M14mm P1.5						1
14.	Copper Washer	10 φ	(t=1.0)					2
15.	Copper Washer	14 φ	(t=2.0)					1
16.	Rubber Cap	8 φ						1
17.	Rubber Cap	12 φ						1
18.	Rubber Cap	22 φ						1
19.	Plug Fitting	25 φ						1
20.	Hose Fitting	8 φ						1
21.	“	19 φ						1
22.	“	5 φ – 8 φ						1
23.	Hose	5 φ	400mm					1
24.	“	19 φ	250mm					1
25.	Silicone Hose	50 φ	Straight (70mm)					2
26.	“	50 φ – 60 φ	Reducer					1
27.	“	70 φ – 80 φ	Reducer					1
28.	Hose band	4 φ						2
29.	Hose band	8 φ	#4					4
30.	Hose band	12 φ	#6					1
31.	Hose band	19 φ	#12					8
32.	Hose band	25 φ	#16					2
33.	Hose band	50 φ	#32					3
34.	Hose band	60 φ	#36					1
35.	Hose band	70 φ	#44					1
36.	Hose band	80 φ	#48					2
37.	Injectors	370cc						4
38.	injector Spacer							1set
39.	Gasket	Turbo Inlet	(TD04)					1
40.	“	Turbo Outlet	(TD04)					1
41.	“	Oil Return	(TD04)					1
42.	Heat shield Bracket							1
43.	Thermo Cloth	100 × 1000mm						1
44.	Zip Ties	150mm						10
45.	Airinx	Bracket						1
46.	Airinx Air Pump Adapter							1
47.	M6x15mm	Stainless	P=1.0	B	-	-	-	1
48.	M6x20mm	Stainless	P=1.0	B	S/W	-	-	2
49.	M6	Stainless	P=1.0	-	S/W	F/W	N	1
50.	M8x20mm	Stainless	P=1.25	B	S/W	-	-	1
51.	M8x30mm	Stainless Stud	P=1.25	B	S/W	-	N	4
52.	M8x38mm	Stainless Stud	P=1.25	B	S/W	-	N	4
53.	M10	Stainless		-	S/W	-	-	3
54.	Pre-paid shipping box							1

Parts List



1

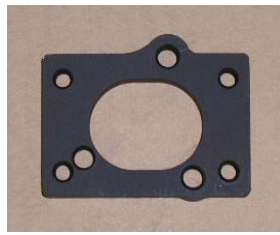

2



3



4



5



6



7



8

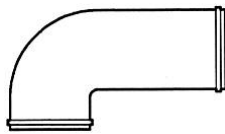

9



10

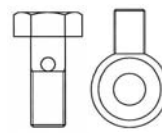

11



12

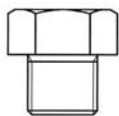

13



14



15

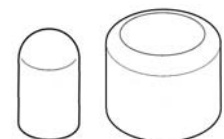

16-18



19

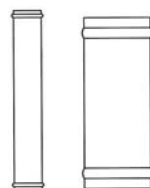

20-21



22



23-24



25



26-27



28

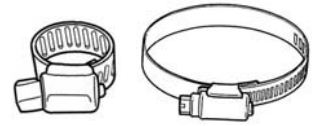

29-36



37

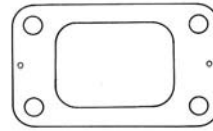

38

39



40



41



42

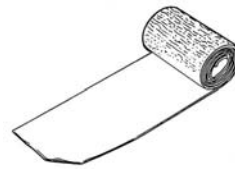

43



44



45



46

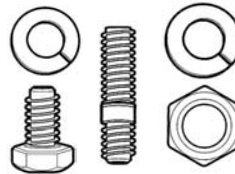

47-53

54

2. Remove Stock Parts

Please refer to the manufacture repair manual for removing stock components.

2-1 Disconnect the batter (-) terminal.

2-2 Remove the engine cover.

2-3 Remove the right side engine under cover.

2-4 Drain the engine oil and coolant fluid

2-5 Remove the compression tube heat insulator.

2-6 Remove any hoses or tubes from the air filter box to the turbo charger.

2-7 Remove the air box and intake hose Assy.

After, remove the waste gate bypass regulator valve and charge pressure bypass valve from the intake hose.

2-8 Remove the front exhaust pipe, O2 sensor, and heat shield.

※ Mark the exhaust clamp before removing.

※ Be sure to separate the pre and post O2 sensors to prevent improper installation order.

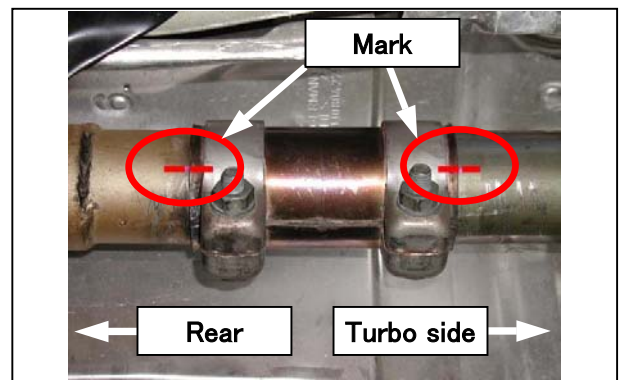

2-9 Remove the drive shaft protective heat cover.

2-10 Remove the turbo oil return pipe.

2-11 Remove the canister hose attached to an aluminum tube on the compressor inlet.

2-12 Remove the exhaust manifold.

2-13 Remove the turbo coolant supply feed and return lines.

2-14 Disconnect the oil supply line from the turbo center housing.

2-15 Remove the turbo charger Assy.

2-16 Remove the turbo oil supply pipe Assy.

After removing, reinstall the oil supply pipe bracket bolts to their original positions.

2-17 Remove the Engine Control Module (ECM).

Remove both wiper arms and panel under the wiper arms. Remove ECM harness and pull out ECM.

※Use caution when pulling out ECM.

2-18 Complete included ECM Upgrade Form and send back with the ECM in the prepaid shipping box.

〈Parts No. 54〉

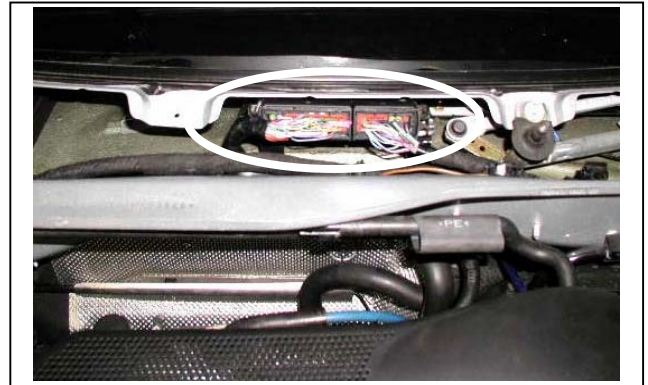

3. Kit Installation

3 - 1 Stock Turbo Coolant Line Replacement

- (1) Plug the stock turbo coolant feed on the block using the provided bolt and copper washer gasket.

〈Parts No.13, 15〉

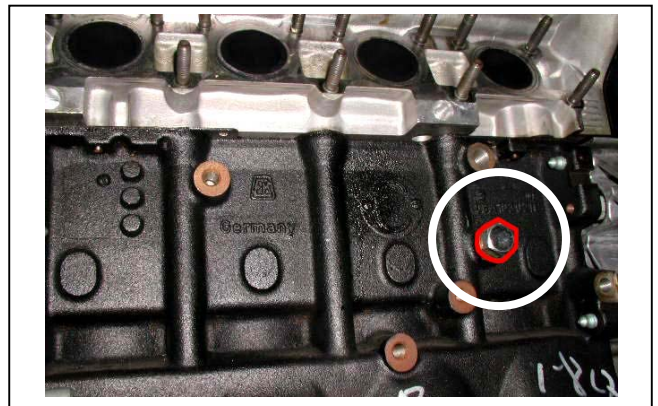

- (2) Plug the stock turbo coolant return pipe using the provided 12 ϕ rubber cap and hose band.

〈Parts No. 17, 30〉

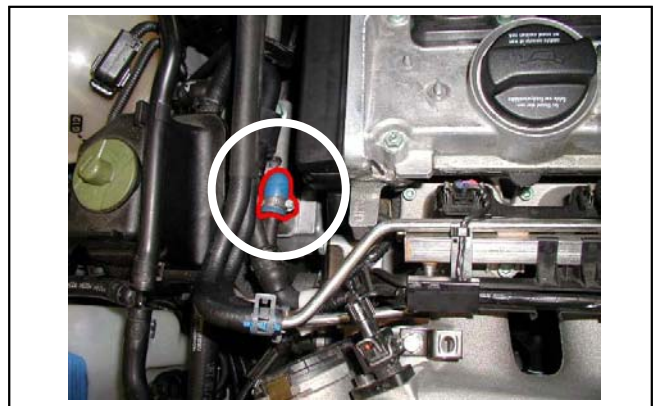

3 - 2 Exhaust Manifold Installation

Install the OE gasket and exhaust manifold.

※ Re use the OE nuts.

※ Please use a new OE gasket.



3 - 3 Turbo Installation

- (1) Place the included O ring where the suction tube connects to the turbo inlet and use provided bolt to install suction tube to turbo.

〈Parts No. 1, 4, 50〉



- (2) Install the banjo fitting to the turbo using the provided banjo bolt and brass washer gaskets. Install the oil pressure feed hose to the banjo fitting.

※ Place the banjo fitting to direct the hose toward the actuator waste gate.

〈Parts No. 10, 11, 14〉

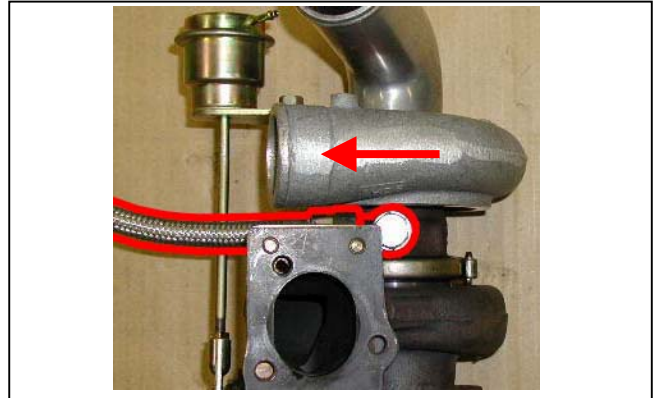

- (3) Install four 8x30mm stud bolts onto the turbine adapter and place a gasket on the flange. Install onto the inlet side of the exhaust housing.

※ Be careful to install studs on the proper side of the flange. Use the picture to the right and below.

〈Parts No. 2, 39, 51〉

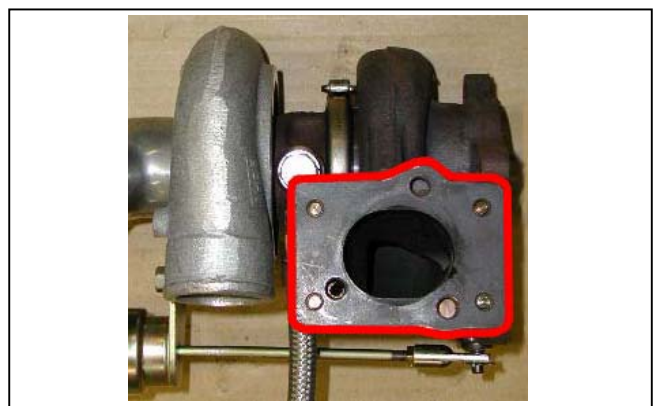
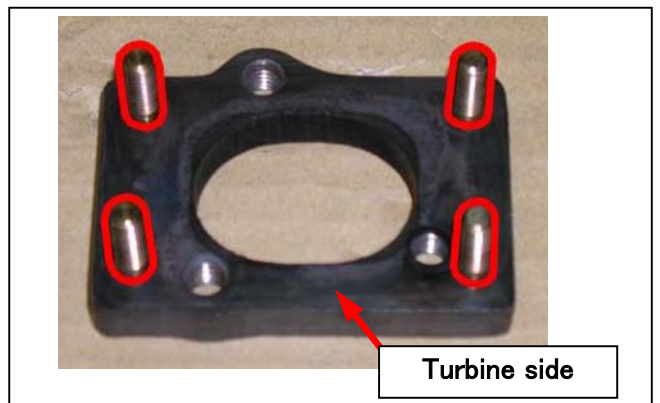

- (4) Install four M8x38mm stud bolts to the outlet of the exhaust housing.

〈Part No. 52〉

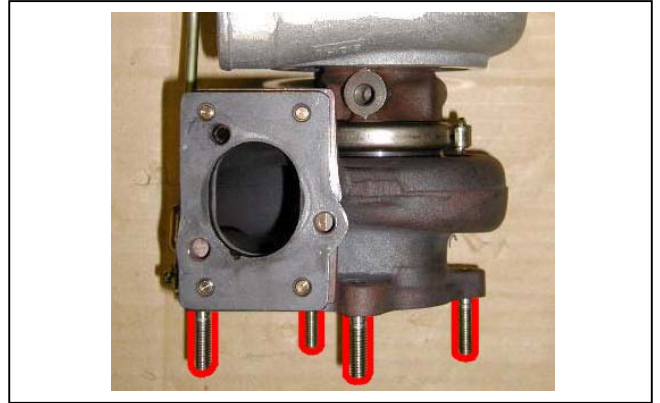

- (5) Connect the provided vacuum hose to the actuator using the provided hose band.

〈Parts No. 23, 28〉

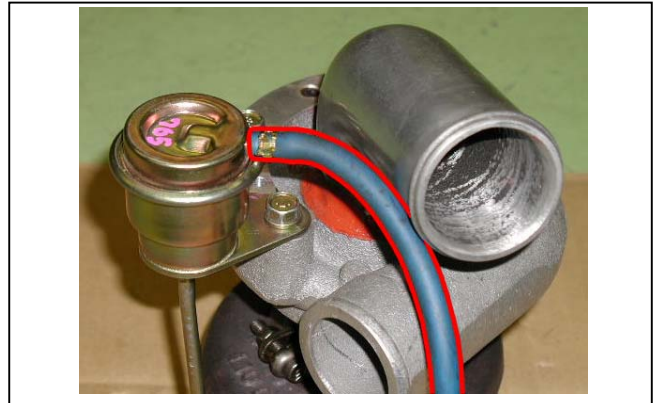

3 - 4 Turbo Charger Installation

- (1) Install the turbo charger to the stock manifold.
Use OE exhaust gasket.
- ※ Use OE bolts and flat washers. Use provided spring washers to install turbo.
 - ※ Please replace manifold gasket when installing.

〈Part No. 53〉

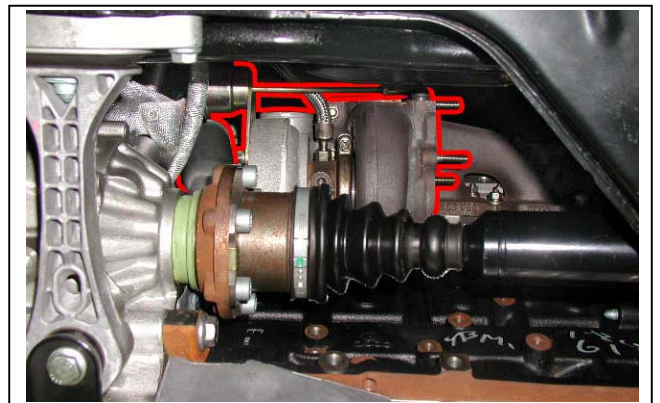

- (2) Use the provided banjo union fitting, stock banjo bolt, and stock aluminum washer gaskets to install the turbine oil pressure feed hose to the engine block oil feed point.

- ※ Please replace aluminum washers.

〈Part No. 12〉

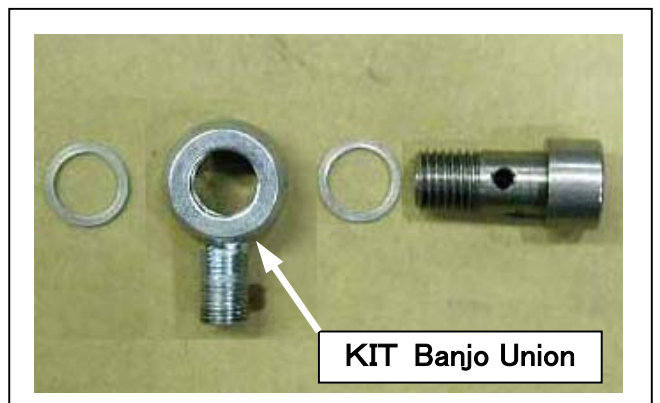

- ※ Route the oil pressure hose behind the heater hose and use cable ties to secure the hose.

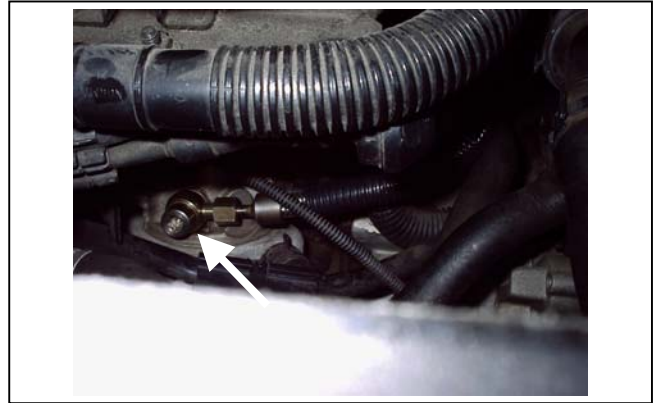

- (3) Use the stock oil return pipe to install between the oil return on the turbine and oil pan.

- ※ Use the provided M6x20mm bolts for the turbine side and stock bolts for the oil pan side of the return pipe. Use stock gaskets.
- ※ Please replace the stock gaskets.

〈Parts No. 41, 48〉

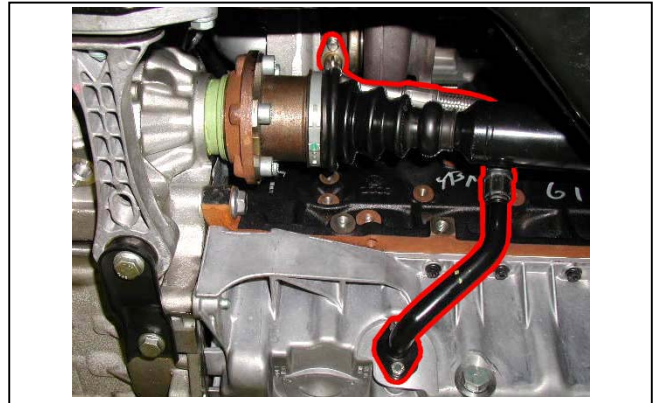

3 - 5 Down Pipe Installation

- (1) Place the down pipe on the exhaust housing outlet flange.

〈Parts No. 3, 52〉

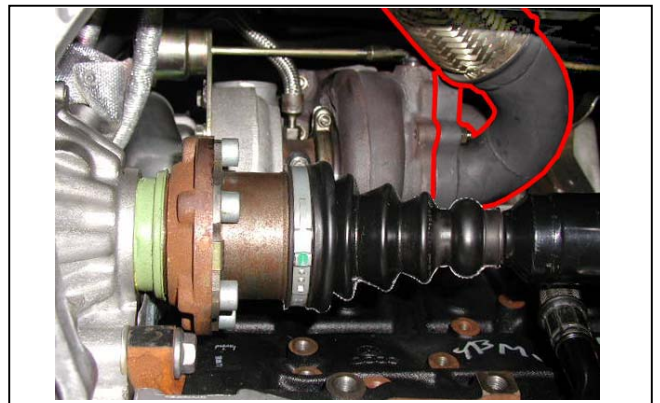

- (2) Cut the front pipe where it is welded to the catalytic converter. (Turbine side of cat.)

- ※ Be sure that catalytic converter is free from debris or metal shavings before welding.

	<p>Please use goggles to prevent and injury while fabricating.</p>
---	--

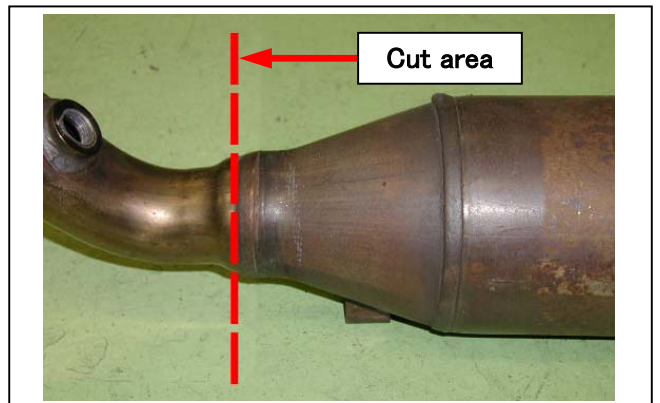

- (3) Place the provided downpipe to fit inside the cut catalytic converter. Connect the muffler piping to the other end of the catalytic converter.
- ※ Align the marks of the exhaust clamp and install. Refer to 2-8 in instructions.

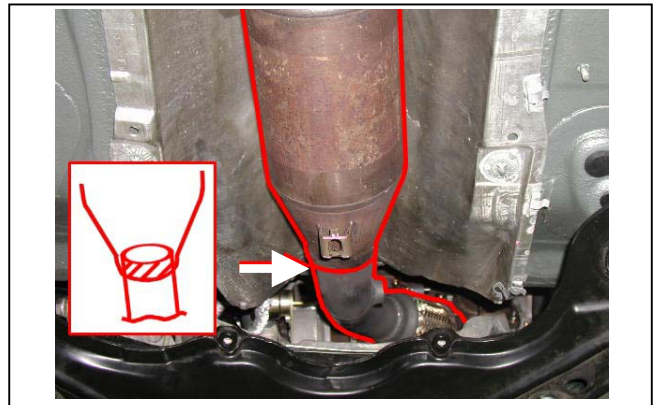

- (4) Weld the catalytic converter and downpipe in a few spots before removing from the vehicle to weld completely.
- Spray welded portion with high temperature paint to prevent rusting.

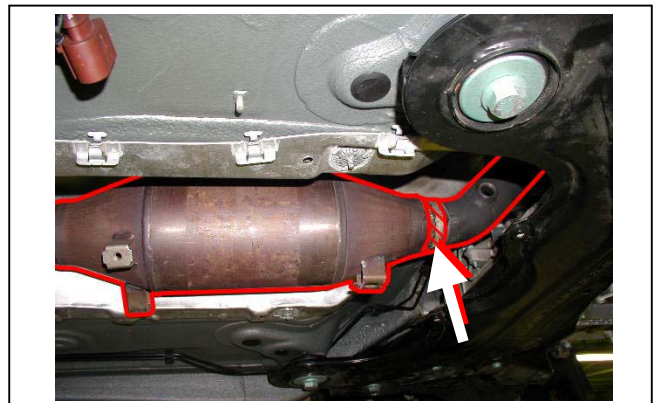

 Please use proper protective equipment when welding.

- (5) Install the pre and post O2 sensors in the front tube.
- ※ Use caution when installing O2 sensors

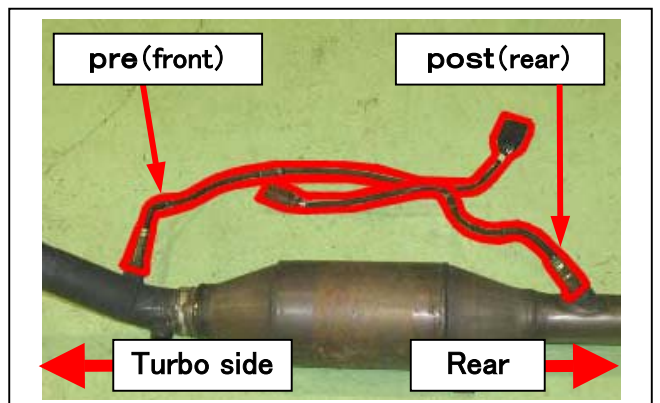

- (6) Place the provided gasket on the turbo exhaust outlet and install downpipe onto turbocharger.
- ※ Check the muffler clearance and angle while installing the down pipe.

〈Parts No. 40,52〉

- (7) Install the factory heat shield and connect the O2 sensor harness connectors. Install the connector cover.

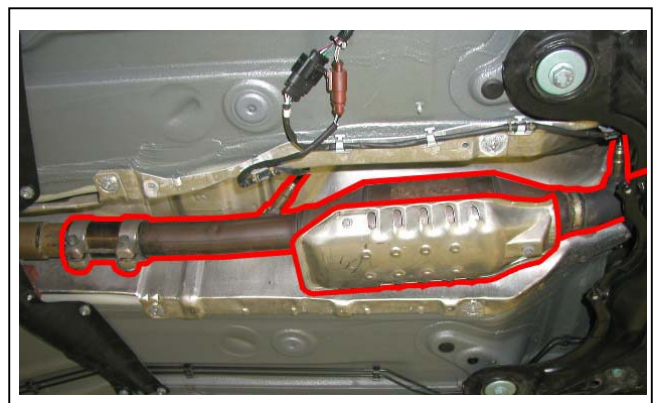

- (8) Install the factory drive shaft heat shield.
- ※ Use factory bolts.
 - ※ Please check to make sure there is clearance around the heat shield after installing.

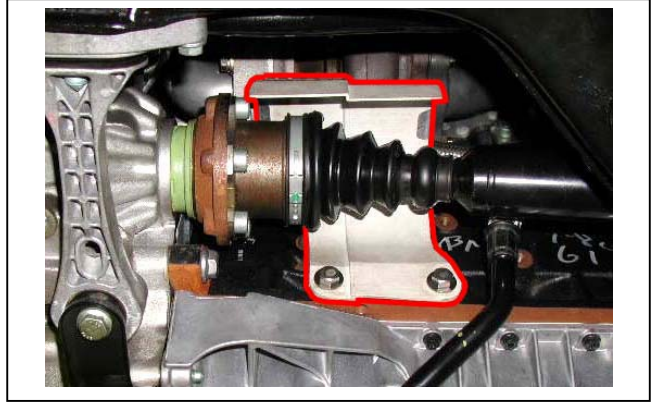

3 - 6 Airinx and Suction Pipe Installation

- (1) Install the 50 φ - 60 φ silicone reducer hose onto the turbo side of the suction pipe and use a hose clamp to attach.
- ※ Remove the O-ring that is on the suction pipe.
 - ※ Wrap the silicone hose with the provided thermo cloth.



〈Parts No. 26, 33, 34, 43〉

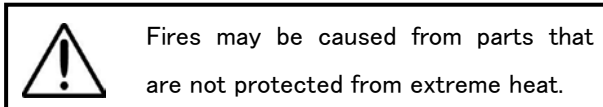

- (2) Install the Airinx air pump adapter and adapter hose onto the Airinx air filter housing.
- ※ Take caution when installing the air pump adapter. Do not cross thread.

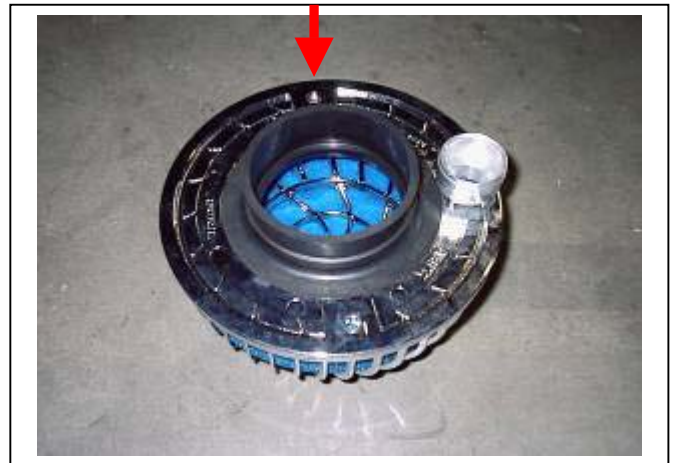

〈Parts No. 5, 6, 46〉

- (3) Remove the one of the bolts on the back of the Airinx housing.

- (4) Install the Air flow meter onto the Airinx filter. Install the 70-80 reducer onto the Air flow meter and place the Airinx Adapter Pipe inside the opposite end of the reducer. Install whole assembly onto factory suction hose. Connect the air pump feed hose to air pump adapter on Airinx housing. Connect the Air Flow Meter harness connector.



〈Parts No. 7, 8, 27, 35, 36〉

- ※ Use factor hose band on factor suction hose.
- ※ Take caution as air flow meter is directional.

- (5) Install Airinx bracket to air filter and body using provided black M6 bolts that came with Airinx filter.

〈Parts No. 45〉



3 – 7 Compression Pipe Installation

- (1) Install the compression tube onto the compressor housing outlet, using the provided hose and hose bands. Connect the stock compression hose to the compression tube. Use the stock hose band for the stock compression hose.

※ Wrap the silicone hose with the provided thermo cloth to prevent melting or fire.

〈Parts No. 9, 25, 33, 43〉

- (2) Use the provided 5 φ – 8 φ hose fitting to connect the actuator hose to the actuator control valve hose. Use the provided hose clamp to secure actuator hose.

〈Parts No. 22, 28, 29, 31, 32, 44〉

- (3) Reconnect hoses onto the stock compression pipe that were removed earlier, using the provided hose bands.

※ Use cable ties to ensure that vacuum hoses do not touch exhaust manifold.

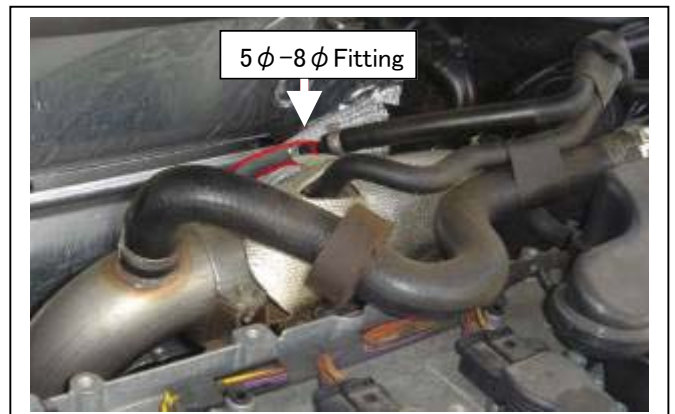

3 – 8 Injector installation

- (1) Disconnect and remove the injector harness connectors and wire harness from the fuel rail.

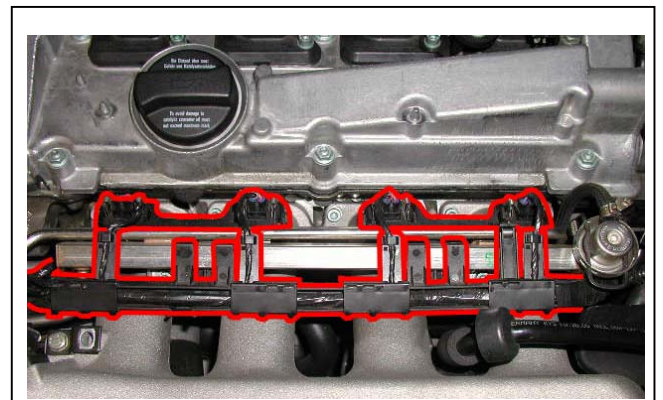

- (2) Disconnect the fuel hoses from the fuel pipes.
※ It is possible that these hoses may be pressurized. When removing, cover hose with a towel to guard from fuel spraying.



Take caution when disconnecting lines.
Wear necessary protective equipment.

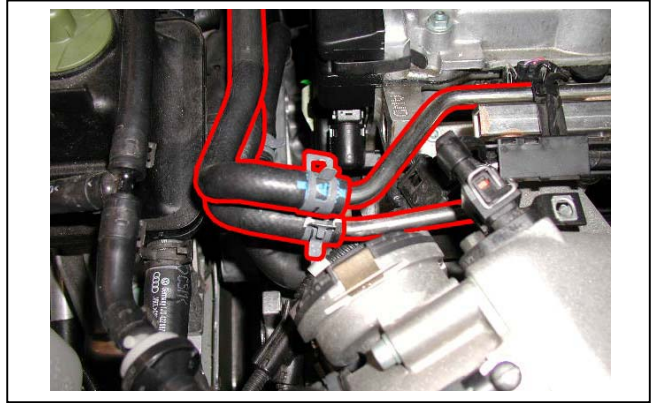

- (3) Disconnect the fuel pressure regulator vacuum hose, remove the fuel rail bolts and remove the fuel rail with the injectors.

- (4) Remove the retaining clip and fuel injector from the fuel rail.

- ※ Make sure the fuel rail is emptied before removing injectors.

- (5) Apply rubber or silicone grease to the injector inlet o ring. Make sure the injector is properly inserted into the fuel rail before installing the retaining clip.

Pressure Regulator Vacuum Hose

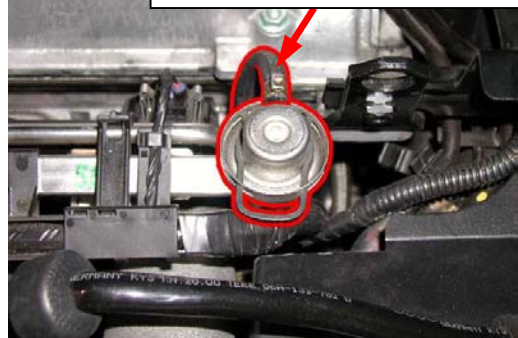

〈Parts No. 37〉

- (6) Install fuel rail with the provided spacer in between the fuel rail mount and intake manifold. Use the factory bolts to install fuel rail.

〈Parts No. 38〉



3 – 9 Engine Control Module Installation (ECM)

Place the ECM back to its original position and connect the harness to the ECM.

3 – 10 Starting Engine

- (1) Refill engine and radiator with proper coolant and engine oils.



Be sure to bleed cooling system after starting.

- (2) Remove the S163 Fusible Link wire to prevent fuel from being delivered while cranking the motor. Turn the starter to build oil pressure in the motor and turbo charger system.

Check for oil and coolant leaks after oil pressure has been raised.

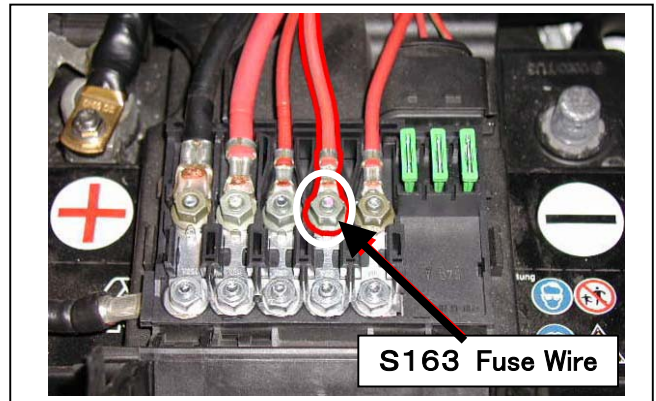

- (3) Reconnect the S163 fusible link wire and turn the ignition key to the on position a few times to build fuel pressure. Check for fuel leaks around injectors and fuel rail. If there are no leaks present, start the car and let idle.
- (4) Check for oil, coolant, fuel, and air leaks while motor is running.
- (5) Install remaining factory parts (engine cover, under cover, wiper Assy, etc.).

This completes the turbo kit installation.

IMPORTANT

- It is very important that you monitor the boost pressure, and make sure not to over boost. Over boosting can cause engine damage. Manifold boost pressure for this turbo kit should be approximately 1.3 bar \pm .1 bar.
- GReddy Performance Products, Inc. is not responsible for any engine damage caused by over boosting (increased boost), modification to the kit, and/or misuse of the product. **NO WARRANTY** is offered.
- Due to lack of control over proper installation and use of this product, **NO WARRANTY** is offered for this kit.